

2/2-Wege Coaxialventil 2/2-way coaxial valve

Baureihe 270 / 271 / 272 Type 270 / 271 / 272

direktgesteuert
direct acting

Schaltfunktion A: NC (stromlos geschlossen)
Function A: NC (normally closed)

Schaltfunktion B: NO (stromlos offen)
Function B: NO (normally open)

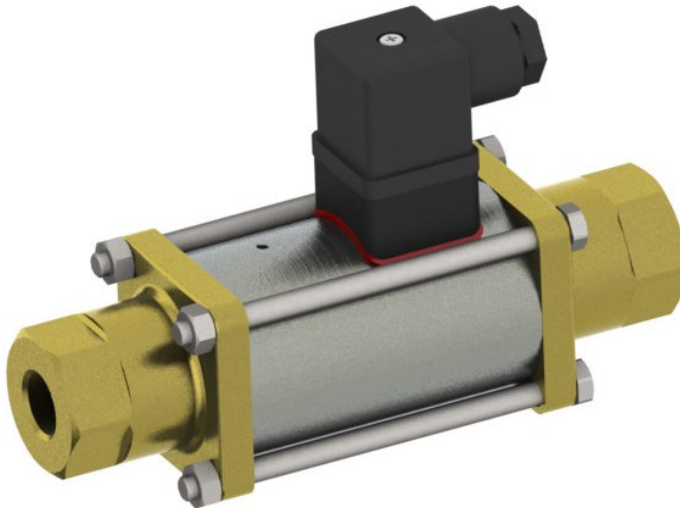
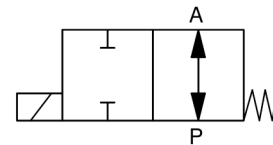
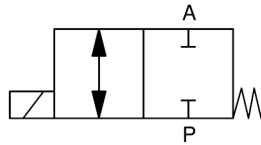

Nennweite	DN 10 – 50	Diameter	DN 10 – 50
Druckbereich	0 – max. 100bar gegendruckdicht bis max. 16bar	Pressure range	0 – max. 100bar Backpressure leakproof up to max. 16bar
Gehäusewerkstoff	Muffenausführung: Messing, 1.4305, 1.4571 Flanschausführung: Stahl verzinkt, Stahl vernickelt, 1.4571	Body material	Threaded version: brass, AISI 303, AISI 316 Flange version: steel galvanized, steel nickel-plated, AISI 316
Dichtwerkstoff	statisch: FKM dynamisch: PTFE Sitzdichtung: FKM, PTFE	Seal material	static: FKM dynamic: PTFE seat seal: FKM, PTFE
Temperatur	Medium: -10 bis +100°C Umgebung: -10 bis +50°C	Temperature	Media: -10 up to +100°C Ambient: -10 up to +50°C
Anschluss	G1/4 – G2 Flansch siehe Tabelle Seite 4	Connection	G1/4 – G2 Flange see table page 4
Durchflussrichtung	P → A max. 100bar A → P max. 16bar	Flow direction	P → A max. 100bar A → P max. 16bar
Elektr. Anschluss	Gerätesteckdose nach DIN EN 175301-803 Bauform A, bei Wechselstrombetrieb mit integriertem Gleichrichter	Electr. connection	Plug acc. DIN EN 175301-803 form A, a.c. operation with rectifier integrate
Anschlussspannung	230V 50Hz, 24V DC, Sonderspannungen	Nominal voltage	230V 50Hz, 24V DC, special voltages
Spannungstoleranz	± 10% nach VDE 0580	Voltage tolerance	± 10% acc. VDE 0580
Einschaltdauer	100% ED	Duty factor	100% ED
Schutzart	IP 65 mit montierter Gerätesteckdose	Protection class	IP 65 with plug mounted
Einbaulage	beliebig	Mounting	in any position

2/2-Wege Coaxialventil
2/2-way coaxial valve
Baureihe 270 / 271 / 272
Type 270 / 271 / 272

Baureihe Type	DN [mm]	Druck Pressure range [bar]	Anschluss Connection	K _v -Wert Flow rate [m ³ /h]	Leistungsaufnahme Power consumption [W]		Gewicht - Messing Weight - brass [kg]
					24V DC	230V 50Hz	
270	10	0 – 40	G1/4, G3/8, G1/2	2,5	35	41	1,7
270	15	0 – 40	G3/8, G1/2, G3/4	5,2	40	45	3,6
270	20	0 – 40	G1/2, G3/4, G1	7,0	45	53	5,4
270	25	0 – 40	G3/4, G1, G1 1/4	12,3	60	68	7,1
270	32	0 – 40	G1, G1 1/4, G1 1/2	20,0	73	76	12,6
270	40	0 – 16	G1 1/2	45,7	73	91	18,3
270	50	0 – 16	G2	47,2	73	91	18,3
271	10	0 – 64	G1/4, G3/8, G1/2	2,5	44	53	1,7
271	15	0 – 64	G3/8, G1/2, G3/4	5,2	50	55	3,6
271	20	0 – 64	G1/2, G3/4, G1	7,0	53	59	5,4
271	25	0 – 64	G3/4, G1, G1 1/4	12,3	77	85	7,1
271	32	0 – 64	G1, G1 1/4, G1 1/2	20,0	73	76	12,6
272	10	0 – 100	G1/4, G3/8, G1/2	2,5	44	53	1,7
272	15	0 – 100	G3/8, G1/2, G3/4	5,2	50	55	3,6
272	20	0 – 100	G1/2, G3/4, G1	7,0	53	59	5,4
272	25	0 – 100	G3/4, G1, G1 1/4	12,3	77	85	7,1
272	32	0 – 100	G1, G1 1/4, G1 1/2	20,0	73	76	12,6

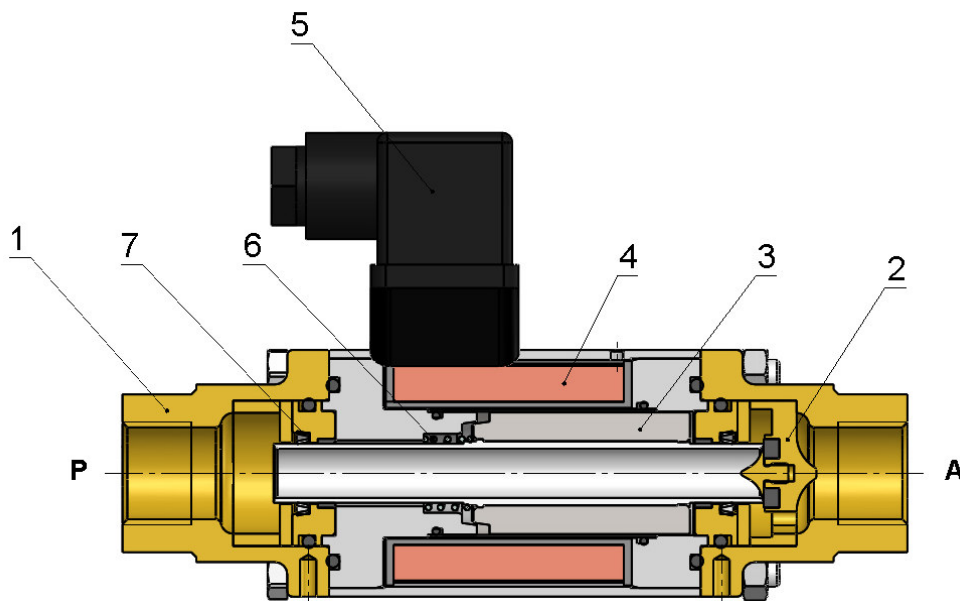
Schnittzeichnung
Sectional drawing

Pos. Pos.	Menge Quantity	Benennung	Description
1	2	Anschlussstück	Adapter fitting
2	1	Ventilsitz	Valve seat
3	1	Anker	Plunger
4	1	Magnet	Solenoid
5	1	Gerätesteckdose	Plug
6	1	Feder	Spring
7	2	PTFE-Stangendichtung	PTFE-rod seal

2/2-Wege Coaxialventil 2/2-way coaxial valve

Baureihe 270 / 271 / 272
Type 270 / 271 / 272

Maßzeichnung Dimension drawing

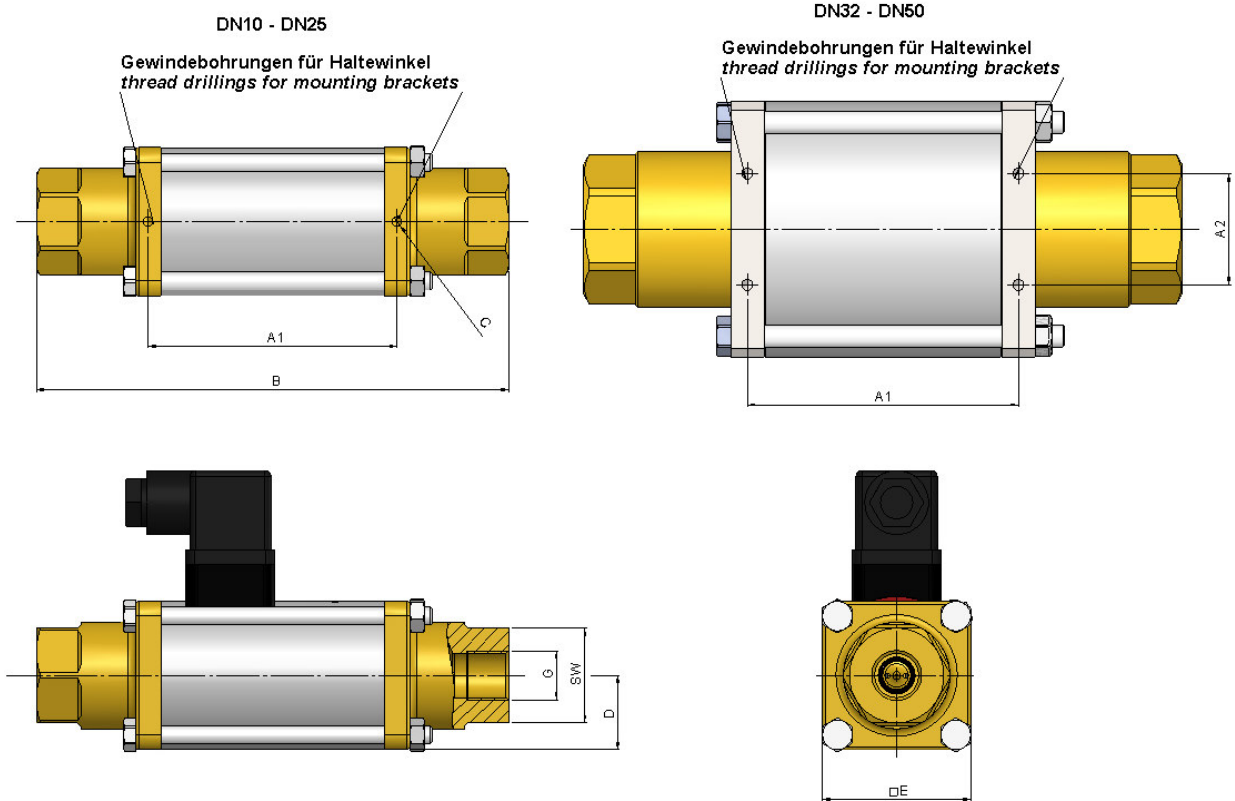

DN [mm]	G	SW	A1 [mm]	A2 [mm]	B [mm]	C	D [mm]	E [mm]
10	1/4, 3/8, 1/2	32	84	-	159,5	M4	25	50
15	3/8, 1/2, 3/4	41	100	-	184	M5	35	70
20	1/2, 3/4, 1	46	108	-	215	M5	40	80
25	3/4, 1, 1 1/4	55	121	-	246	M5	45	90
32	1, 1 1/4, 1 1/2	60	122	50	269	M6	57,5	115
40	1 1/2	75	131	60	304	M6	65	130
50	2	75	131	60	304	M6	65	130

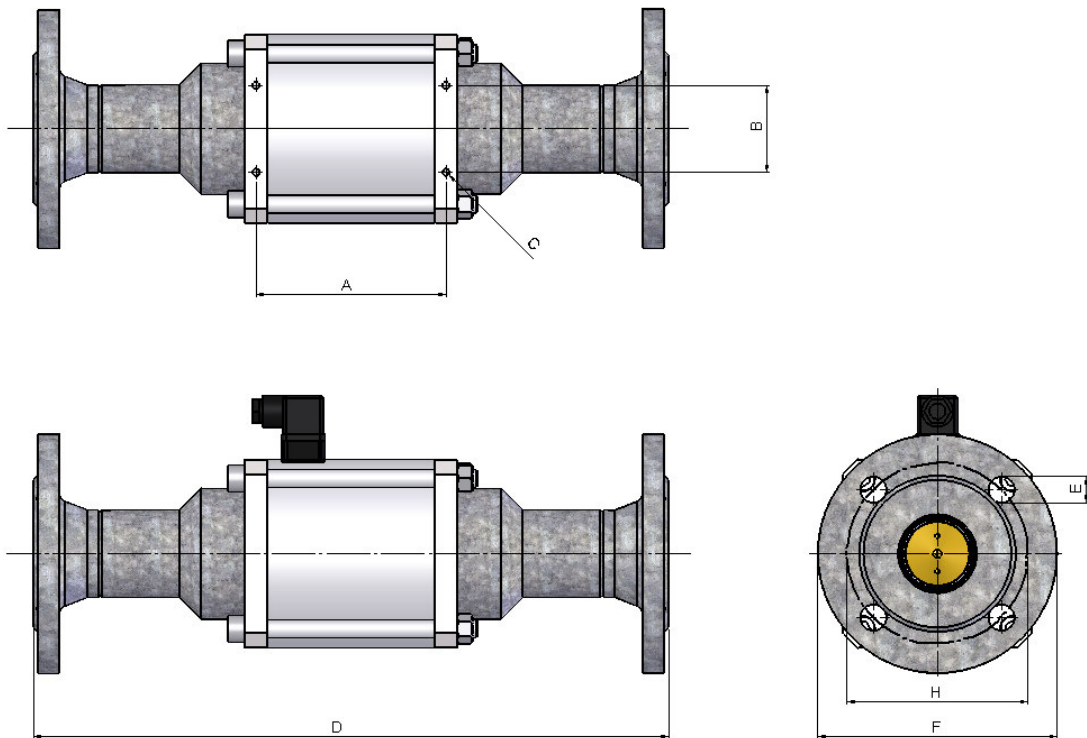
2/2-Wege Coaxialventil
2/2-way coaxial valve
Baureihe 270 / 271 / 272
Type 270 / 271 / 272
Maßzeichnung Flanschventile
Dimension drawing flange valves

Flansch - Norm Fange - standard		Druckstufe PN Pressure rating	DN Flansch DN flange	DN Ventil DN valve	K _v -Wert Flow rate	A	B	C	D	E	F	H
DIN	EN	[bar]			[m ³ /h]	[mm]	[mm]	[mm]	[mm]	[mm]	[mm]	[mm]
2633	-	16	15	15	5,2	100	-	M5	242	14	95	65
2633	-	16	20	20	7,0	108	-	M5	269	14	105	75
2633	-	16	25	25	12,3	121	-	M5	302	14	115	85
2633	-	16	32	32	20,0	122	50	M6	324	18	140	100
2633	-	16	40	40	38,2	131	60	M6	385	18	150	110
2633	1092-1 Typ 11	16	50	50	47,2	131	60	M6	385	18	165	125
2635	1092-1 Typ 11	40	15	15	5,2	100	-	M5	242	14	95	65
2635	1092-1 Typ 11	40	20	20	7,0	108	-	M5	269	14	105	75
2635	1092-1 Typ 11	40	25	25	12,3	121	-	M5	302	14	115	85
2635	1092-1 Typ 11	40	32	32	20,0	122	50	M6	324	18	140	100
2635	1092-1 Typ 11	40	40	32	20,0	131	60	M6	324	18	150	110
2637	1092-1 Typ 11	100	15	15	5,2	100	-	M5	242	14	105	75
-	1092-1 Typ 11	100	20	20	7,0	108	-	M5	269	18	130	90
2637	1092-1 Typ 11	100	25	25	12,3	121	-	M5	302	18	140	100
-	1092-1 Typ 11	100	32	32	20,0	122	50	M6	324	22	155	110
2637	1092-1 Typ 11	100	40	32	20,0	131	60	M6	324	22	170	125

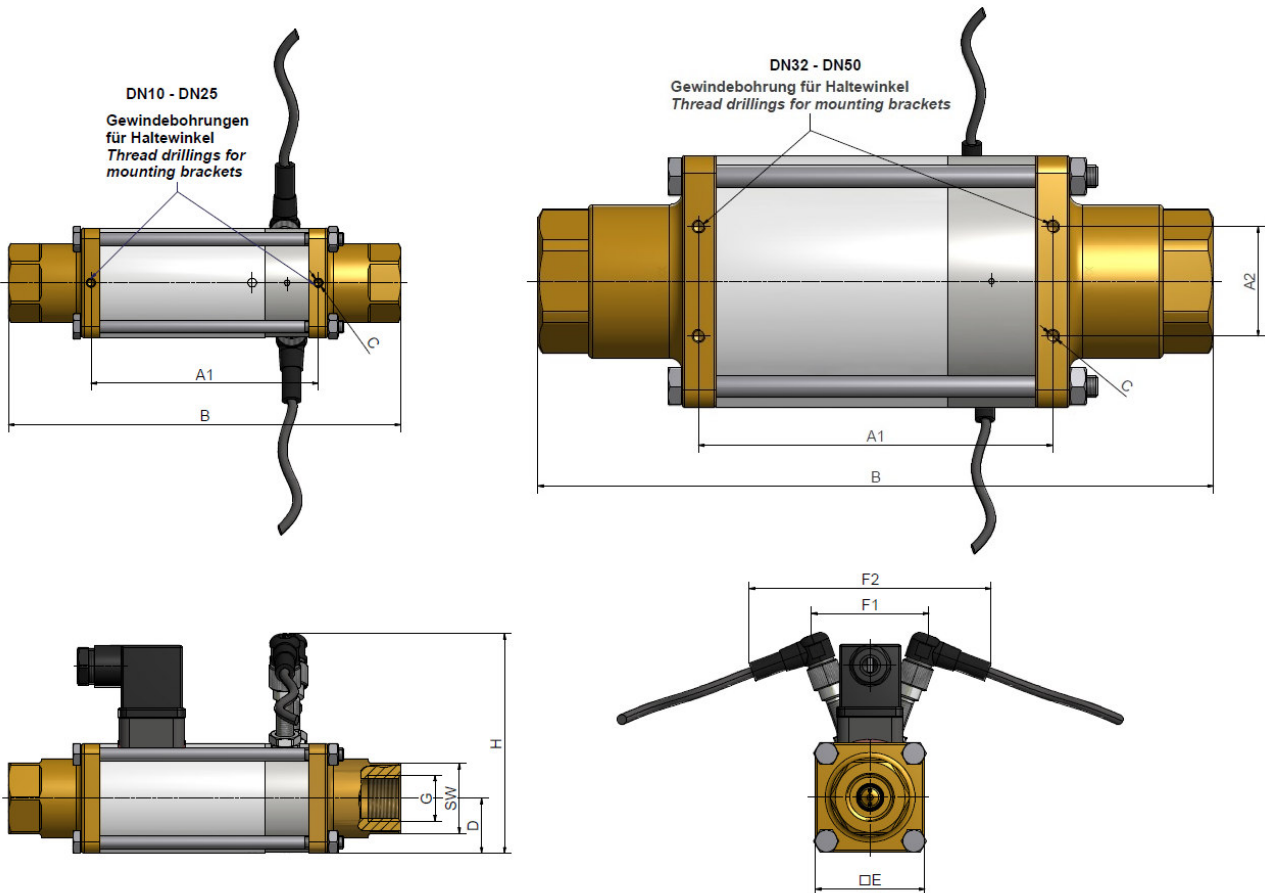
2/2-Wege Coaxialventil
2/2-way coaxial valve
Baureihe 270 / 271 / 272
Type 270 / 271 / 272
Maßzeichnung Ventile mit Endschalter*
Dimension drawing valves position indication*

DN [mm]	G	SW	A1 [mm]	A2 [mm]	B [mm]	C	D [mm]	E [mm]	F1 [mm]	F2 [mm]	H [mm]
10	1/4, 3/8, 1/2	32	104	-	179,5	M4	25	50	65	121	115
15	3/8, 1/2, 3/4	41	130	-	214	M5	35	70	67	124	128
20	1/2, 3/4, 1	46	138	-	245	M5	40	80	67	124	132
25	3/4, 1, 1 1/4	55	156	-	281	M5	45	90	70	127	141
32	1, 1 1/4, 1 1/2	60	162	50	309	M6	57,5	115	73	130	158
40	1 1/2	75	171	60	344	M6	65	130	66	123	156
50	2	75	171	60	344	M6	65	130	66	123	156

* Elektrische Stellungsanzeige 2-fach (E2) dargestellt, auch in 1-fach (E1) möglich.
 Electrical position indication double (E2) shown, also possible in single (E1).

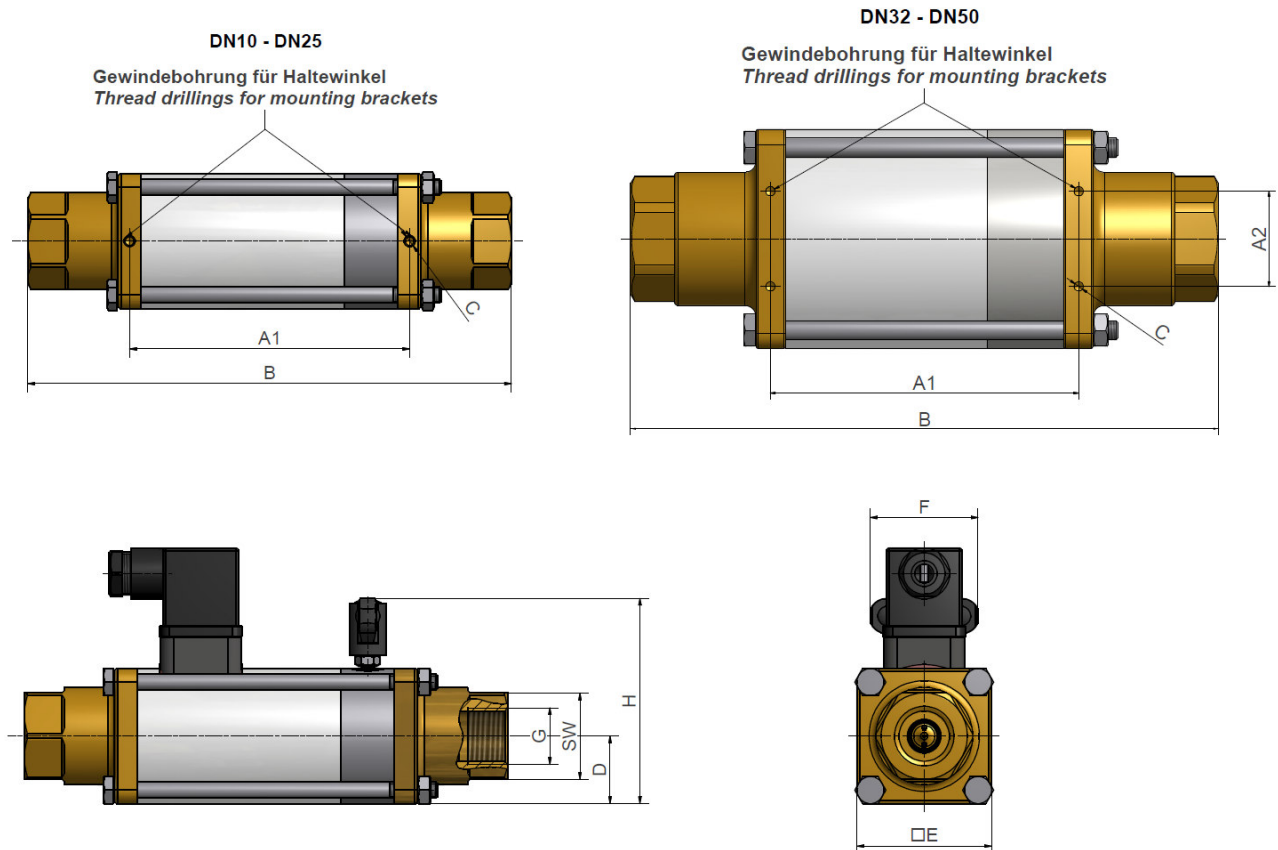
2/2-Wege Coaxialventil
2/2-way coaxial valve
Baureihe 270 / 271 / 272
Type 270 / 271 / 272
Maßzeichnung Ventile mit Handnot
Dimension drawing valves with manual override

DN [mm]	G	SW	A1 [mm]	A2 [mm]	B [mm]	C	D [mm]	E [mm]	F [mm]	H [mm]
10	1/4, 3/8, 1/2	32	84	-	179,5	M4	25	50	55	78
15	3/8, 1/2, 3/4	41	100	-	214	M5	35	70	55	98
20	1/2, 3/4, 1	46	108	-	245	M5	40	80	55	108
25	3/4, 1, 1 1/4	55	121	-	281	M5	45	90	55	118
32	1, 1 1/4, 1 1/2	60	122	50	309	M6	57,5	115	55	143
40	1 1/2	75	131	60	344	M6	65	130	55	158
50	2	75	131	60	344	M6	65	130	55	158

2/2-Wege Coaxialventil 2/2-way coaxial valve

Baureihe 270 / 271 / 272 Type 270 / 271 / 272

Typenschlüssel Type code

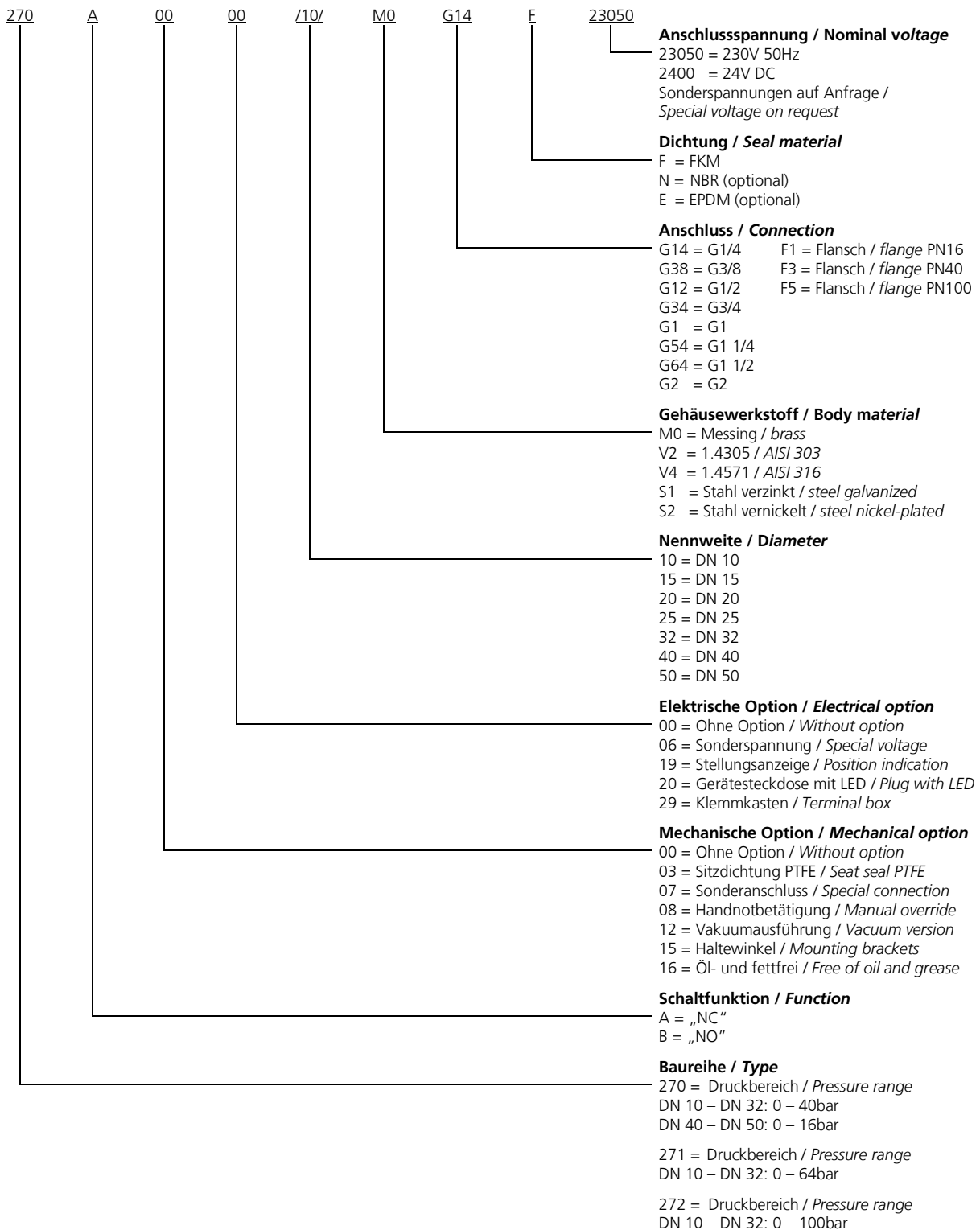

Die Typenbezeichnung setzt sich zusammen aus:
Structure of the order specification:

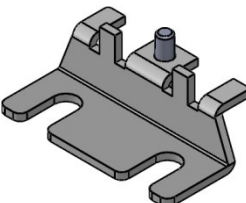
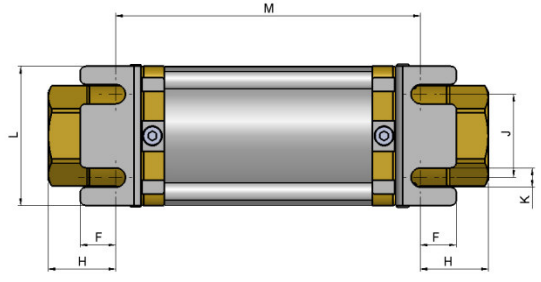
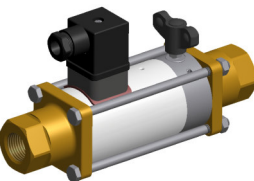
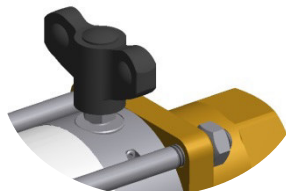
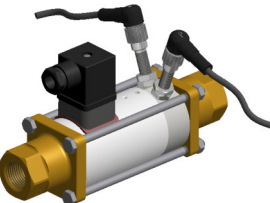
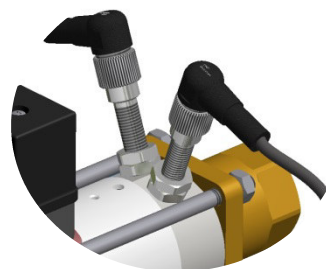

2/2-Wege Coaxialventil
2/2-way coaxial valve
Baureihe 270 / 271 / 272
Type 270 / 271 / 272
Zubehör
Accessories

	<p>Haltewinkel <i>Mounting brackets</i></p> <p>Mechanische Option = 15 <i>Mechanical option = 15</i></p>	 <table border="1" data-bbox="842 795 1460 1086"> <thead> <tr> <th>DN [mm]</th> <th>F [mm]</th> <th>H [mm]</th> <th>J [mm]</th> <th>K [mm]</th> <th>L [mm]</th> <th>M [mm]</th> </tr> </thead> <tbody> <tr> <td>10</td> <td>10</td> <td>23,5</td> <td>30</td> <td>7</td> <td>50</td> <td>113</td> </tr> <tr> <td>15</td> <td>10,5</td> <td>22,5</td> <td>45</td> <td>7</td> <td>70</td> <td>139</td> </tr> <tr> <td>20</td> <td>15,3</td> <td>33,5</td> <td>50</td> <td>7</td> <td>80</td> <td>149</td> </tr> <tr> <td>25</td> <td>16</td> <td>34</td> <td>60</td> <td>8,5</td> <td>90</td> <td>178</td> </tr> <tr> <td>32</td> <td>6</td> <td>37</td> <td>78</td> <td>6,5</td> <td>115</td> <td>195</td> </tr> <tr> <td>40</td> <td>6</td> <td>40</td> <td>98</td> <td>6,5</td> <td>130</td> <td>224</td> </tr> <tr> <td>50</td> <td>6</td> <td>40</td> <td>98</td> <td>6,5</td> <td>130</td> <td>224</td> </tr> </tbody> </table>	DN [mm]	F [mm]	H [mm]	J [mm]	K [mm]	L [mm]	M [mm]	10	10	23,5	30	7	50	113	15	10,5	22,5	45	7	70	139	20	15,3	33,5	50	7	80	149	25	16	34	60	8,5	90	178	32	6	37	78	6,5	115	195	40	6	40	98	6,5	130	224	50	6	40	98	6,5	130	224
DN [mm]	F [mm]	H [mm]	J [mm]	K [mm]	L [mm]	M [mm]																																																				
10	10	23,5	30	7	50	113																																																				
15	10,5	22,5	45	7	70	139																																																				
20	15,3	33,5	50	7	80	149																																																				
25	16	34	60	8,5	90	178																																																				
32	6	37	78	6,5	115	195																																																				
40	6	40	98	6,5	130	224																																																				
50	6	40	98	6,5	130	224																																																				
	<p>Handnotbetätigung <i>Manual override</i></p> <p>Mechanische Option = 08 <i>Mechanical option = 08</i></p>																																																									
	<p>Stellungsanzeige <i>Position indication</i></p> <p>Elektrische Option = 19 <i>Electrical option = 19</i></p> <p>Mögliche Ausführung: <i>Possible execution:</i></p> <ul style="list-style-type: none"> - E1 einfach E1 single - E2 zweifach E2 double <p>Kabellänge Winkelkupplung: 2,0m <i>Cable length angle coupling: 2,0m</i></p> <ul style="list-style-type: none"> - Optional 10,0m Optionally 10,0m 																																																									

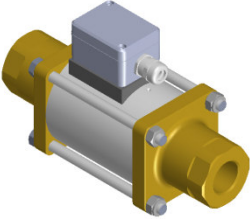
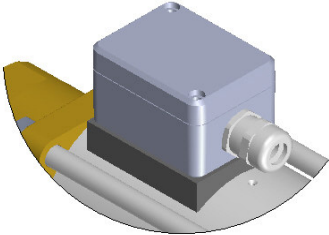
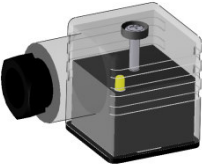
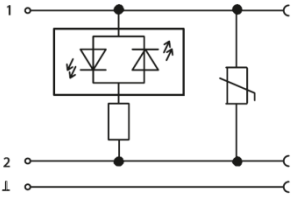
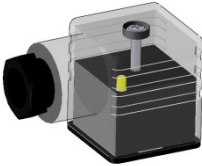
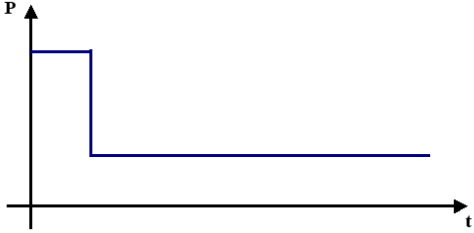
2/2-Wege Coaxialventil
2/2-way coaxial valve
Baureihe 270 / 271 / 272
Type 270 / 271 / 272

	<p>Klemmkasten <i>terminal box</i></p> <p>Schutzart: IP 65 <i>Protection class: IP 65</i></p> <p>PG11-Verschraubung <i>PG11-fitting</i></p> <p>Elektrische Option = 29 <i>Electrical option = 29</i></p>	
	<p>Gerätesteckdose mit LED <i>Plug with LED</i></p> <p>Elektrische Option = 20 <i>Electrical option = 20</i></p>	
	<p>Gerätesteckdose mit Leistungsabsenkung 24V DC Bauform A <i>Plug with power reduction form A</i></p> <p>Elektrische Option = 07 <i>Electrical option = 07</i></p>	
	<p>Gerätesteckdose M12x1 <i>Plug with M12x1</i></p>	

Weitere Optionen und Zubehör stimmen wir gerne auf Ihre Anforderungen ab.
We gladly coordinate further options and accessories according to your requirements.